

**ID Sized For
2/0 [62mm²] Cable**

**Dimple For Center Stop
3 Places**

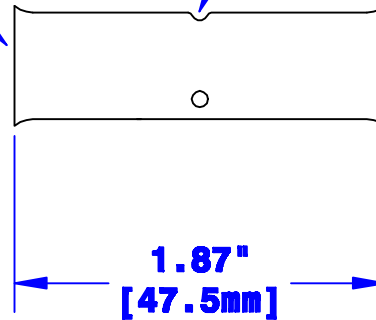

Property of QUICKCABLE® 3700 Quick Drive Franksville, WI 53126 U.S.A. www.quickcable.com	TITLE 2/0 [62mm²] Max Lug Butt Splice
	PART # 6655

Confidential and Proprietary Information

					Drawn By Jim H	Date 12-02-09	Checked By Mike E	Scale None
					Tolerances, unless otherwise noted All dimensions are ref only			
Rev	Date	ECN#	By	Description				

Material & Treatment 100% Copper Tin plated	Drawing # 6655-INFO	REV
Sheet 1 of 1		