

Quick Cable Reserves The Right to Alter Product Type, Their Technical Data, Dimensions, Style And Accessories without Prior Notification.

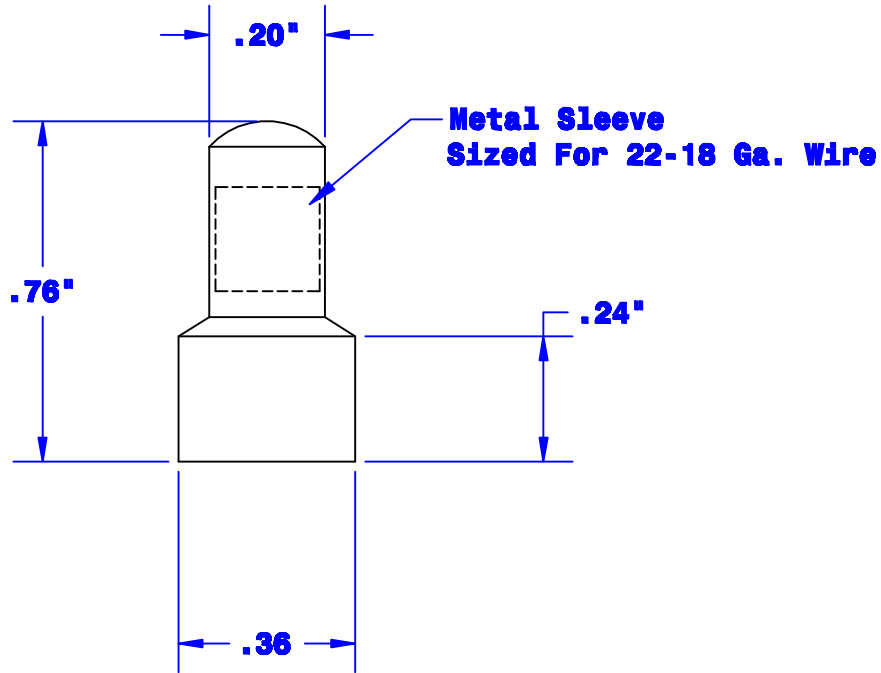

Property of QUICKCABLE® 3700 Quick Drive Franksville, WI 53126 U.S.A. www.quickcable.com		TITLE Connector, Closed End
		PART # 169110
Confidential and Proprietary Information		
Material & Treatment Opaque Nylon	Drawing # 169110-Info	REV
		Sheet 1 of 1

				Drawn By Jim H	Date 12-03-10	Checked By Damian	Scale None
				Tolerances, unless otherwise noted Dimensions are reference only			
Rev	Date	ECN#	By	Description			