

Quick Cable Reserves The Right to Alter Product Types, Their Technical Data, Dimensions, Style And Accessories Without Prior Notification.

Prefilled With Rosin & Solder
Sized for 1/0 [50mm²] Cable
3/4" [19.1mm] Min. Depth
Chamfered Lead-In, Both Ends

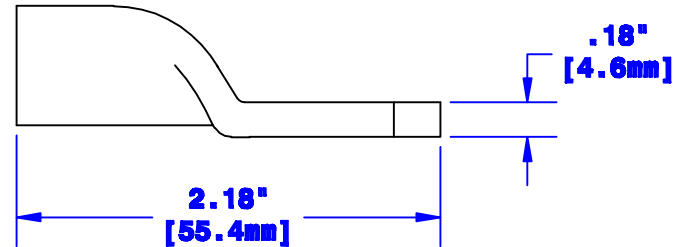
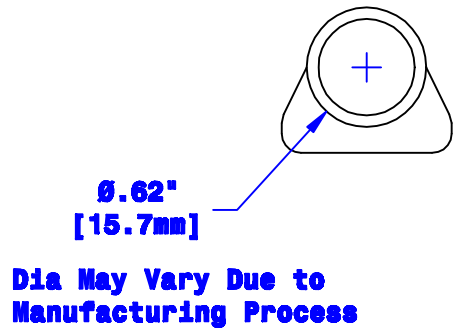
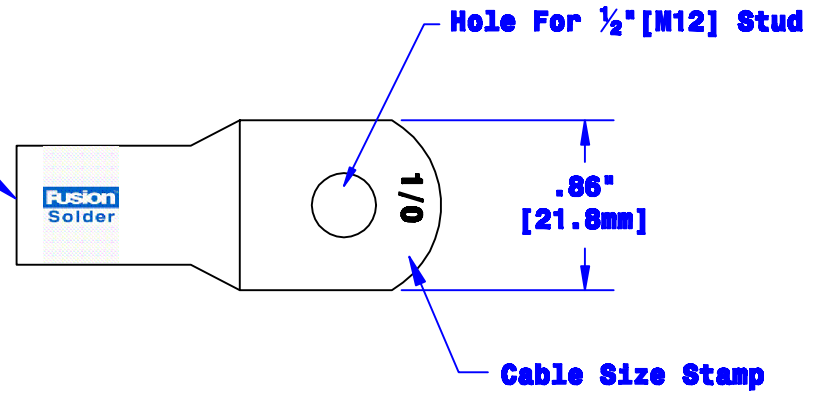

Property of QUICKCABLE 3700 Quick Drive Franksville, WI 53126 U.S.A. www.quickcable.com	TITLE 1/0[50mm ²] Magna Lug, Fusion
	PART # 141137

Confidential and Proprietary Information

				Drawn By Paul	Date 03-12-03	Checked By Mike E	Scale None
B	04-13-12	2450	JMM	Redrawn; printing info updated			
Rev	Date	ECN#	By	Description			

Tolerances, unless otherwise noted
Dimensions are reference only

Material & Treatment Copper Tube Tin Plated	Drawing # 141137-Info	REV B
Sheet 1 of 1		